

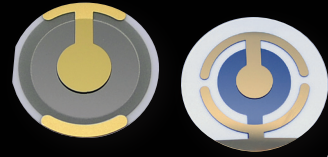

Fil-Tech

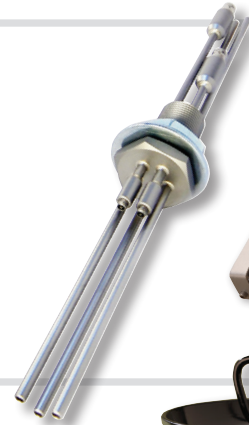

Quality & Savings From Stock

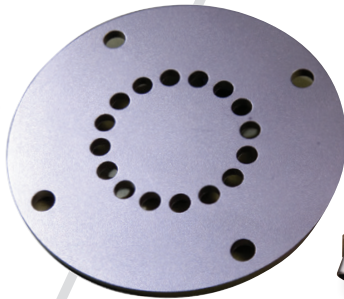
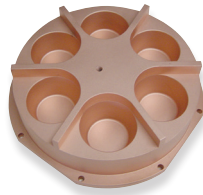

SCAN FOR OUR FULL CATALOG

800-743-1743 - 617-227-1133

paula@filtech.com

www.filtech.com Online Ordering



Liquid Plating Crystals

1" Diameter 5MHz polished, plano/plano crystals for measurements in gas or liquid

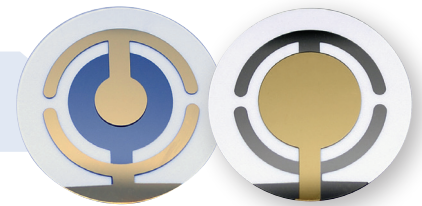

| Fil-Tech | | | SRS | | INFICON | |
|----------|-----------|------------------------|---------|----------|----------|-----------|
| | ELECTRODE | | | | | |
| QM1001 | \$30 each | Cr/Au | 0100RX1 | \$395/10 | 149273-1 | \$61 each |
| QM1003 | 35 | Ti/Au | 0100RX3 | 395/10 | 149257-1 | 51 |
| QM1003-1 | 40 | Ti/Ti | 0100RX4 | 595/10 | 149274-1 | 67 |
| QM1004 | 40 | Ti/Pt | | | | |
| QM1005 | 35 | Ti/Al2O3 | | | | |
| QM1007 | 40 | Cr/Au/Ni | | | | |
| QM1008 | 30 | Stress Relieving Alloy | | | | |
| QM1010 | 40 | Cr/Au/Mo | | | | |
| QM1011 | 40 | Ti/Mo | | | | |
| QM1012 | 40 | Cr/Au/Cu | | | | |
| QM1013 | 40 | Cr/Au/Zn | | | | |
| QM1015 | 40 | Cr/Au/SiO2 | | | | |
| QM1018 | 35 | Cr/Au/Cr | | | | |

Fil-Tech Crystals

.550" Diameter
4.95MHz polished,
plano/plano.

Comparable to Q-SENSE

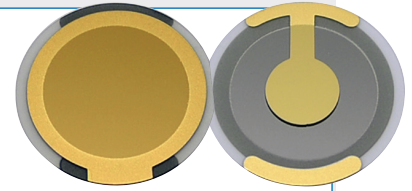

| Fil-Tech | | | Q-SENSE | |
|----------|-----------|------|---------|---------|
| | ELECTRODE | | | |
| QSX0301 | \$50 each | Au | QSX 301 | \$295/5 |
| QSX0303 | 50 | SiO2 | QSX 303 | 450/5 |
| QSX0304 | 50 | SS | QSX 304 | N/A |
| QSX0309 | 50 | Al | | |
| QSX0310 | 50 | Ti | | |
| QSX0313 | 50 | Cu | | |
| QSX0314 | 80 | Pt | QSX 314 | 450/5 |



Quality Crystals®

In 6MHz and 5MHz in Gold, Stress-Relieving Alloy®, Longer Life Gold®, Silver and Advanced Adhesion Alloy®. The metal used for the contact electrode on the crystal has an effect on the crystal's ability to measure film thickness. Choose the best electrode for your coating process.

| Fil-Tech | INFICON STYLE | FREQUENCY & P/N |
|----------|----------------------------|------------------|
| QI8010 | \$48 Gold | 6MHz 008-010-G10 |
| QI8012 | 48 Longer Life Gold | 6MHz |
| QI8008 | 48 Stress Relieving Alloy | 6MHz 750-769-G1 |
| QI8014 | 48 Advanced Adhesion Alloy | 6MHz |
| QI8009 | 48 Silver | 6MHz 008-009-G10 |

| Fil-Tech | BALZERS STYLE | |
|----------|---------------------------|------------------|
| QB104G | \$55 Gold | 5MHz B489-025-T |
| QB104GL | 55 Longer Life Gold | 5MHz |
| QB104A | 55 Stress Relieving Alloy | 5MHz |
| QB104S | 55 Silver | 5MHz BN845-104-T |

| Fil-Tech | SLOAN STYLE | |
|----------|---------------------------|-------------|
| QS3952 | \$52 Gold | 5MHz 103952 |
| QS3952GL | 52 Longer Life Gold | 5MHz |
| QS3954 | 52 Stress Relieving Alloy | 5MHz |
| QS3950 | 52 Silver | 5MHz 103950 |

| Fil-Tech | INTELLEMETRICS STYLE | |
|----------|---------------------------|-------------|
| QI8010F | \$48 Gold | 6MHz SN66NG |
| QI8012F | 48 Longer Life Gold | 6MHz |
| QI8008F | 48 Stress Relieving Alloy | 6MHz |
| QI8009F | 48 Silver | 6MHz SN66NS |

Typical System

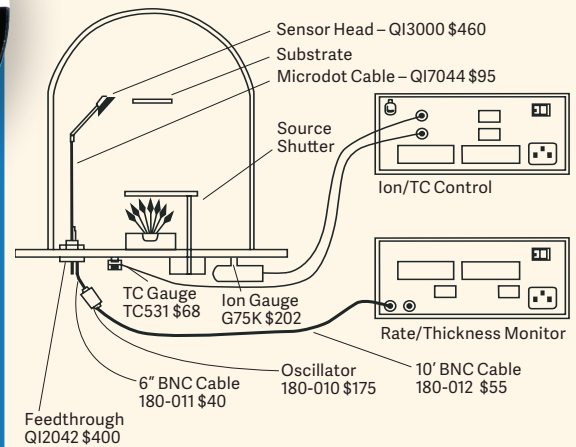

Monitor/Controller Options

| | | |
|----------|------------------------|---------|
| SQM-160 | Rate/thickness monitor | \$1,910 |
| STM-2XM | Rate/thickness monitor | 2,955 |
| XTC/3 | Deposition Controller | 4,480 |
| SQC-310 | Deposition Controller | 3,220 |
| IC6 | Deposition Controller | 12,520 |
| CYGNUS 2 | Deposition Controller | 12,690 |

Components Required for a Complete System

| | | |
|---------|--------------------------------|-------|
| 180-010 | Remote analog oscillator | \$175 |
| 180-011 | 6" BNC cable M/F | 40 |
| 180-012 | 10' BNC cable M/M | 55 |
| QI3000 | Sensor head single sensor | 460 |
| QI7044 | 30" Microdot cable | 95 |
| QI2042 | Feedthrough 1" bolt | 400 |
| TC531 | Thermocouple gauge | 68 |
| G75K | Ion gauge, 3/4" kovar, iridium | 186 |

INFICON Multi-Film Rate/Thickness Monitors and Controllers



Fil-Tech is an authorized distributor for INFICON® products. Choose your INFICON monitor or controller, or call 617-227-1133 with your application requests and for best pricing.



SQM-160 S-2-R Multi-Film Rate/Thickness Monitor

Has 2 sensor inputs standard and 4 additional sensor inputs optional with 2 recorder outputs to provide analog rate and thickness signals. Sensor inputs can be assigned to different materials, averaged for accurate deposition, or configured for a dual sensor. Rate displays of 0.1Å/sec or 0.01Å/sec and frequency or mass display can be selected. Four relay outputs allow control of the source of sensor shutters, signal time and thickness setpoints, and signal crystal failure.

SQM160-S-2-R \$1,910



STM-2XM-GI Channel Rate/Thickness Monitor

Combines high accuracy with flexible programming and easy operation at an affordable price. Has 8 programmable digital inputs, 8 programmable digital outputs, and 4 analog outputs. It manages complicated co-deposition with an independent mode allowing it to operate as 2 completely separate monitors with temporal averaging for superior accuracy. Programmable features include shutter delay, time/power monitoring, and rate sampling.

STM-2XM-GI \$2,955

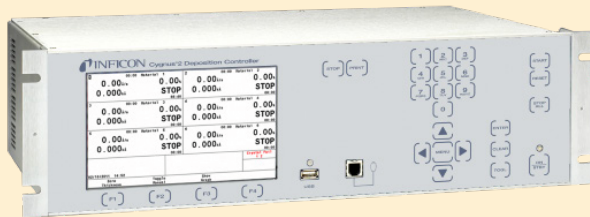

Cygnus® 2 Thin Film Deposition Controller

Provides exceptional value by combining the proven performance of INFICON thin film controllers with unique features, all designed for you to achieve the most from your OLED process. Cygnus 2 uses the ModeLock frequency measurement system to provide stable, high-resolution rate and thickness measurement with an industry leading rate resolution of .004Å/s every 1/10 second.

CYG2-2101000 \$12,690



XTC/3 Thin Film Deposition Controller

INFICON's deposition controller for single and multiple-layer processes. The XTC/3 has patented ModeLock that provides mode hop prevention for consistent quality. Offers highly accurate control of deposition rate and thickness, the capacity for virtually any number of layers, easy installation, and extremely high reliability to ensure productivity.

XC3S-1000 \$4,480
XC3M-1000 \$7,670



SQC-310 Thin Film Deposition Controller

Offers advanced electronics, improved display and an affordable price. Choose SQC-310 for sequential deposition or the SCQ-310C for codeposition. SQC-310 comes standard RS-232 and USB, a "Quick Setup" menu, Windows® program, is accurate with ±0.03 Hz resolution at 10 reading/second and storage capacity for up to 100 processes, 1,000 layers and 50 films. Available in English or Chinese.

SQC310-2-R-1 \$3,220
SQC310C-4-R-1 \$5,820



IC6 Thin Film Deposition Controller

Provides exceptional value by combining the proven performance of INFICON thin film controllers with unique features, all designed to achieve the most from your deposition process. The IC6 uses the ModeLock frequency measurement system to provide stable, high-resolution rate and thickness measurement with an industry-leading rate resolution of 0.0043 Å/s every 1/10 second.

IC6-110100 — \$12,520

FEEDTHROUGHS

Single

Single 1" Bolt QI2042

\$400

For Single
Sensors

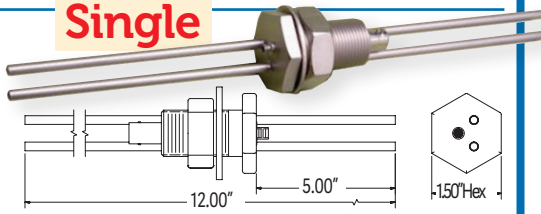

Single 2 3/4" Flange QI2043

\$460

For Single Sensors

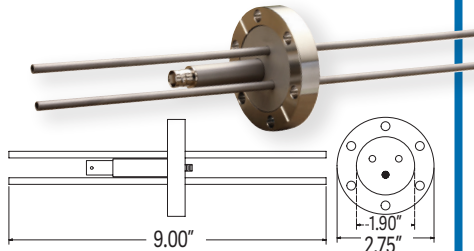

Dual

Dual 1" Bolt QI2000 \$865

For Dual Sensors

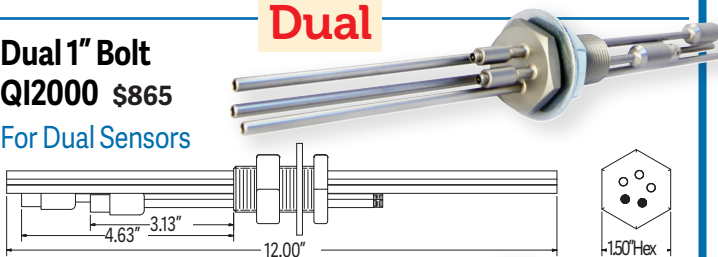

Dual 2 3/4" Flange QI2080

\$920

For Dual
Sensors

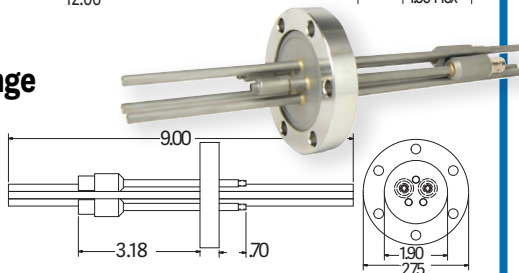

All feedthrough lines 3/16" OD steel tubing.
Custom feedthroughs available.

Sensor Head Parts, Oscillators and Cables

| PART | INFICON | | Fil-Tech | |
|------------------|----------------|------|----------|------|
| Ceramic Retainer | 007-023 | \$80 | QI7023 | \$70 |
| Finger Spring | 750-171-P1 | 34 | QI0171 | 32 |
| Crystal Holder | 750-172-G1 | 86 | QI0172 | 75 |
| Crystal Holder | Fil-Tech Style | | QI3010 | 80 |
| Oscillator | 783-500-013 | 217 | 180-010 | 175 |

| CABLES | INFICON | | Fil-Tech | |
|----------------|---------|-------|----------|------|
| Coaxial 30" | 007-044 | \$120 | QI7044 | \$95 |
| Special Length | | | QI7044X | 115 |
| Right Angle | | | QI7045 | 95 |

Cables have an extra layer of Teflon to protect the shielded cable from deposition material, insuring longer life.

| CABLES | PHELPS | | Fil-Tech | |
|----------------|---------|--|----------|-------|
| Unsheathed 8" | Pe16016 | | QP16016 | \$100 |
| Unsheathed 36" | Pe16018 | | QP16018 | 100 |
| Unsheathed 48" | Pe16020 | | QP16020 | 100 |

Cables have exposed metal sheath.

SENSOR HEADS

Single

In Line QI3000 \$460

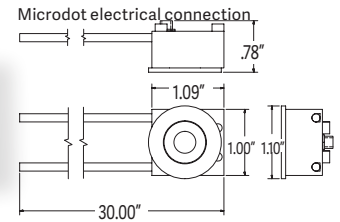

In Line w/Shutter QI5000 \$1,790

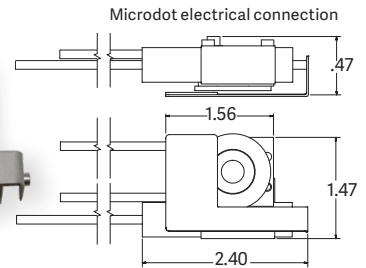
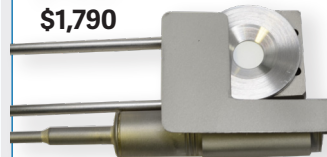

Right Angle QI4000 \$460

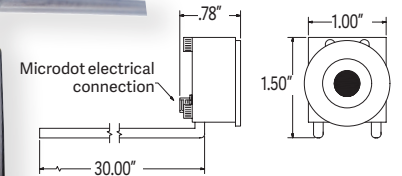
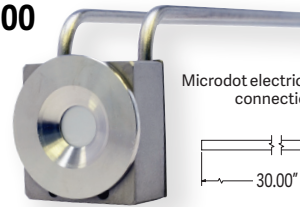

Right Angle w/Shutter QI4050 \$1,790

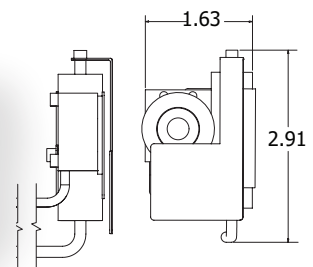
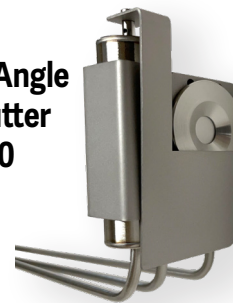

Round Perpendicular QI3500* \$520

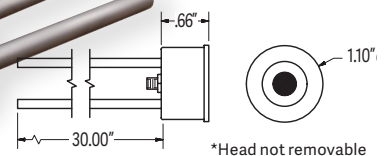
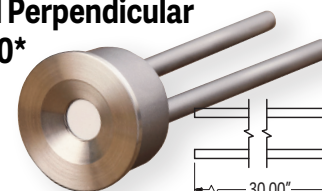

Custom sensor heads, feedthroughs and assemblies available.

All sensor lines 1/8" OD stainless tubing except QI3600 with 3/16".

Dual with Shutter

In Line QI6000
\$2,125

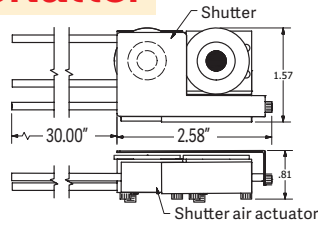
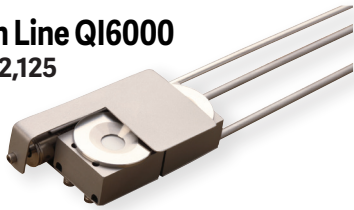

Right Angle QI7000
\$2,125

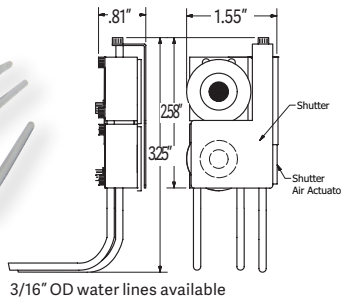

Round Perpendicular QI3600
\$2,250

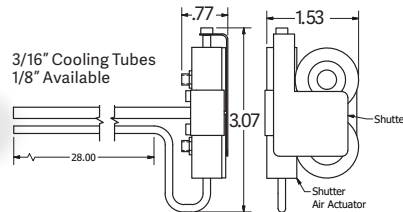
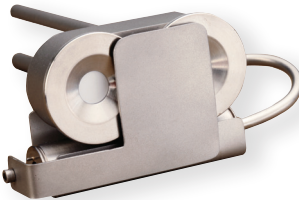

Sensor Head With Internal Oscillator & Deep Water Pocket

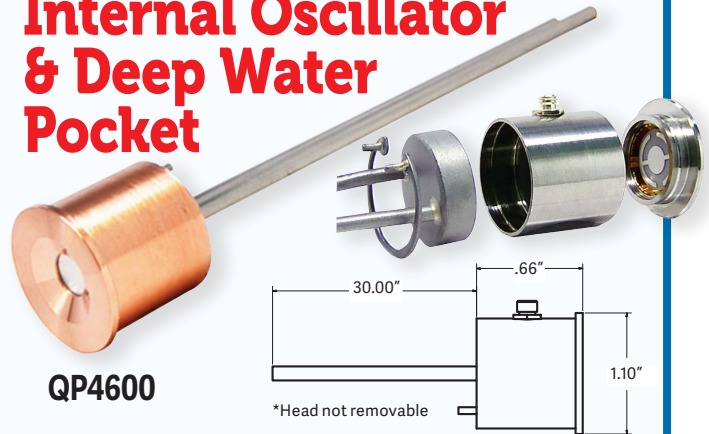

QP4600

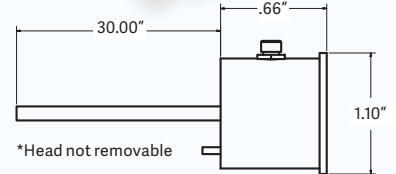

QP4500

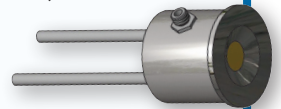

Features

- Stainless steel construction
- Internal oscillator for 5MHz and 6MHz
- Removable from water lines for easy repair
- Deep water pocket for superior cooling
- Copper construction option for superior cooling

| | | |
|--------------------------|--------|-------|
| Sputter Head, SS | QP4500 | \$600 |
| Sputter Head Cap, SS | QP4501 | 75 |
| Sputter Head, Copper | QP4600 | 660 |
| Sputter Head Cap, Copper | QP4601 | 92 |

Specify crystal diameter for correct crystal holder style

Positional Sensor Heads

QI1100 \$1,130
Includes Coaxial Cable

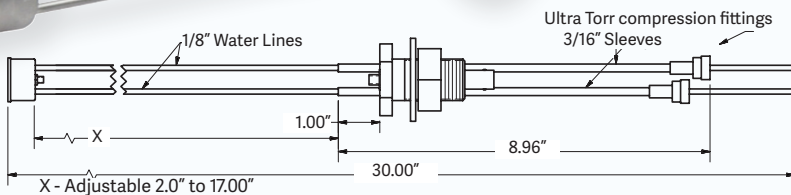
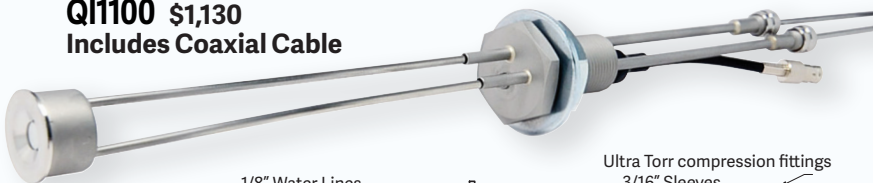

QC12 Crystal Sensor System

Sensor head holds 12 crystals and allows continuous monitoring without process interruption

System Includes

- 2 Multi-crystal sensor heads
- 2 1" bolt or 2 3/4" flange feedthroughs
- Controller
- Vacuum, air and cooling cables
- 12 Complimentary Quality Crystals

The QC12 is precise and reliable and features a small footprint with easy installation and reload. Compatible with INFICON, Sigma, Maxtek and Sycon monitors.

POR



Bakeable Sensor Heads

Our Bakeable Sensor Heads are used for UHV and High Temp processes up to 300° C. The QI1200 is TIG welded to a rotatable conflat flange. A 1" baseplate bolt is available but the Viton O-ring will limit the temp to 205°C. The coaxial connection is sealed inside a rigid 3/16" OD stainless steel tube with cable included. Cooling tubes are 3/16" OD to maximize cooling. Sensor heads can be built to order with your choice of feedthrough type and length.

QI1200 \$1,150 Includes Coaxial Cable

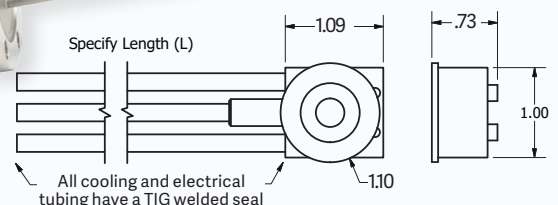
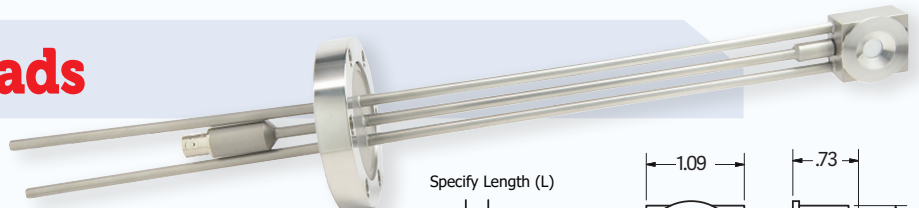

ELECTRON BEAM GUN PARTS

**ALL ITEMS
IN STOCK**

Multi-Pocket Emitters

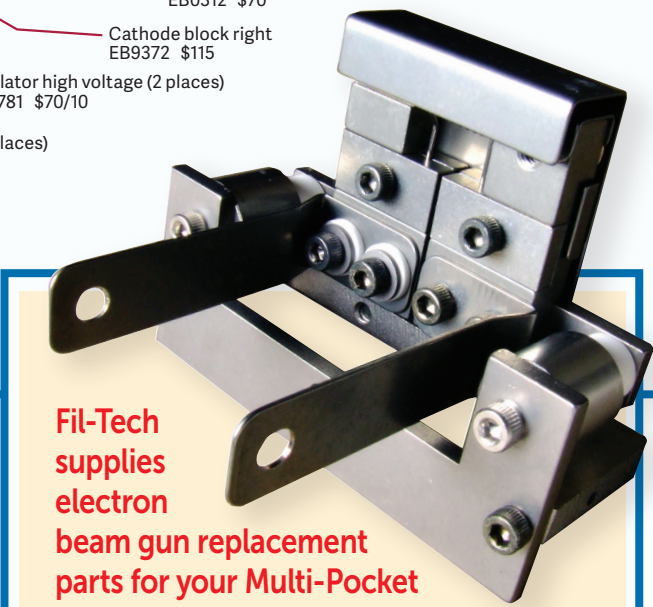
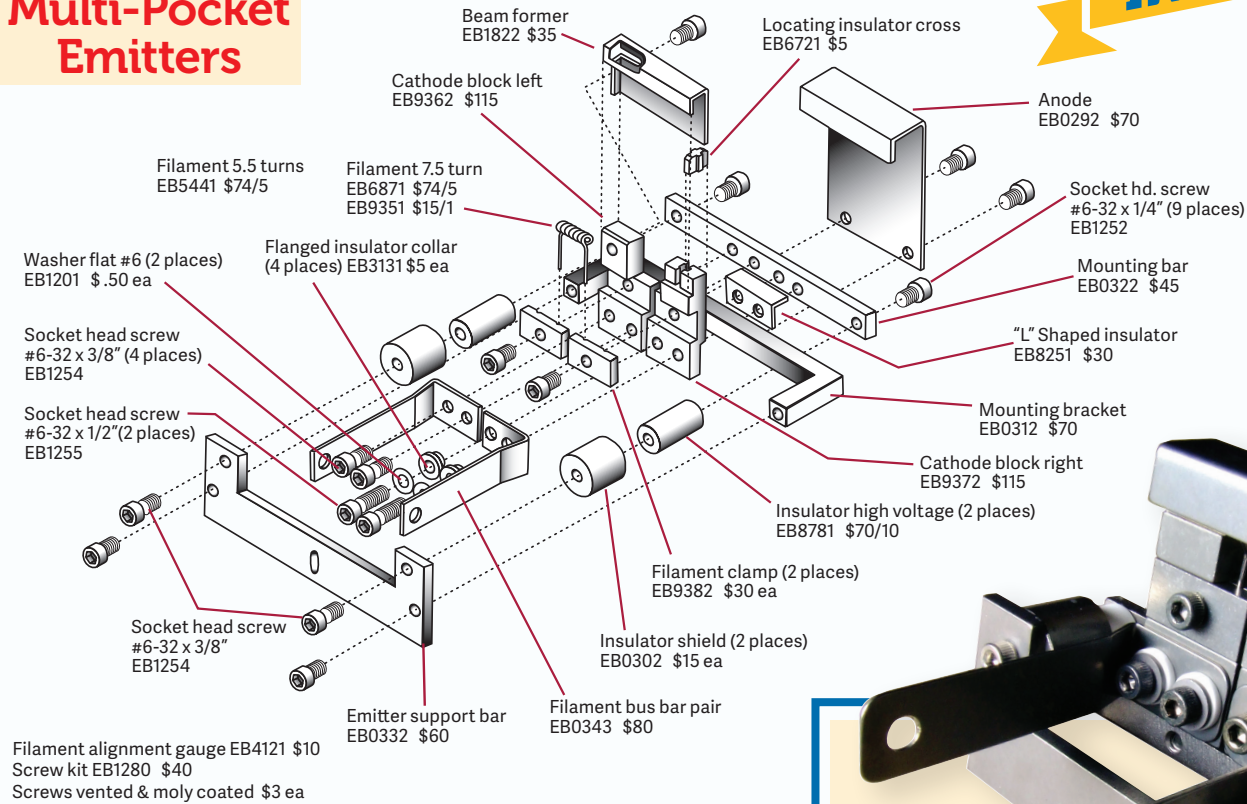

Fil-Tech supplies electron beam gun replacement parts for your Multi-Pocket and High Performance emitters from Temescal, Telemark, Thermionics, Satisloh, MeiVac, Sloan, and Leybold. Our insulators, filaments, metal parts and electromagnetic coils are drop-in replacements for the listed OEM parts. We can also rebuild your emitters.

Multi-Pocket Emitter Parts

| | TEMESCAL | TELEMARK | Fil-Tech | |
|-----------------------|-------------|-----------------------|----------|------|
| Anode | 0204-0292-0 | 273-0003-1 | EB0292 | \$75 |
| Beam Former | 0415-1822-0 | 273-0004-2 | EB1822 | 35 |
| Beam Former, Tantalum | 0303-9392-0 | N/A | EB9392 | 50 |
| Cathode Block, Left | 0303-9362-0 | 273-0031-1 | EB9362 | 115 |
| Cathode Block, Right | 0303-9372-0 | 273-0032-1 | EB9372 | 115 |
| Emitter Support Bar | 0204-0332-0 | 273-0018-1 | EB0332 | 60 |
| Filament Clamp | 0303-9382-0 | 273-0033-3/273-0033-4 | EB9382 | 30 |
| Filament Bus Bar Set | 0204-0343-0 | 273-0035-1/273-0036-1 | EB0343 | 80 |
| Insulator Shield | 0204-0302-0 | 273-0011-1 | EB0302 | 15 |
| Mounting Bar | 0204-0322-0 | 273-0017-1 | EB0322 | 45 |
| Mounting Bracket | 0204-0312-0 | 273-0019-1 | EB0312 | 70 |
| Seal, Quad Ring | 2108-0215-0 | N/A | EB0215 | 2 |
| Seal, RL Gasket | 0020-4811-2 | N/A | EB4811 | 6 |
| Emitter Assembly | 0204-0284-0 | 273-0150-1 | EB0284 | 700 |

Emitter Assemblies

| | TEMESCAL | TELEMARK | Fil-Tech | |
|-----------------------------|-------------|------------|-------------------------------------|-------|
| Multi Pocket | 0204-0284-0 | 273-0150-1 | EB0284 Temescal EB0150M Telemark | \$700 |
| Single Pocket | 0304-1914-0 | 253-0150-1 | EB1914 | 700 |
| High Performance | 0916-8294-0 | N/A | EB8294 | 800 |
| Emitter Rebuilding Service* | N/A | N/A | EBREBLD | 350 |

*Includes glass beading and chemically cleaning all metal parts, replacing filament, screws (all vented), insulators, and reassembling. Metal parts not included.

| Insulators | TEMESCAL | TELEMARK | Fil-Tech | |
|--|-------------|------------|----------|-------|
| Flanged/Collar | 0303-3131-0 | 273-0006-1 | EB3131 | \$5 |
| Locating/Cross | 0303-6721-0 | 273-0005-1 | EB6721 | 5 |
| High Voltage | 0602-8781-0 | 273-0010-1 | EB8781 | 70/10 |
| High Voltage | 0418-4631-0 | 273-3010-1 | EB4631 | 7 |
| Cathode Block "L" Shaped | 0916-8251-0 | 273-0008-1 | EB8251 | 30 |
| Telemark and Temescal parts are interchangeable. | | | | |
| SLOAN | 126-116 | | EB6116 | \$22 |

High Performance Emitters

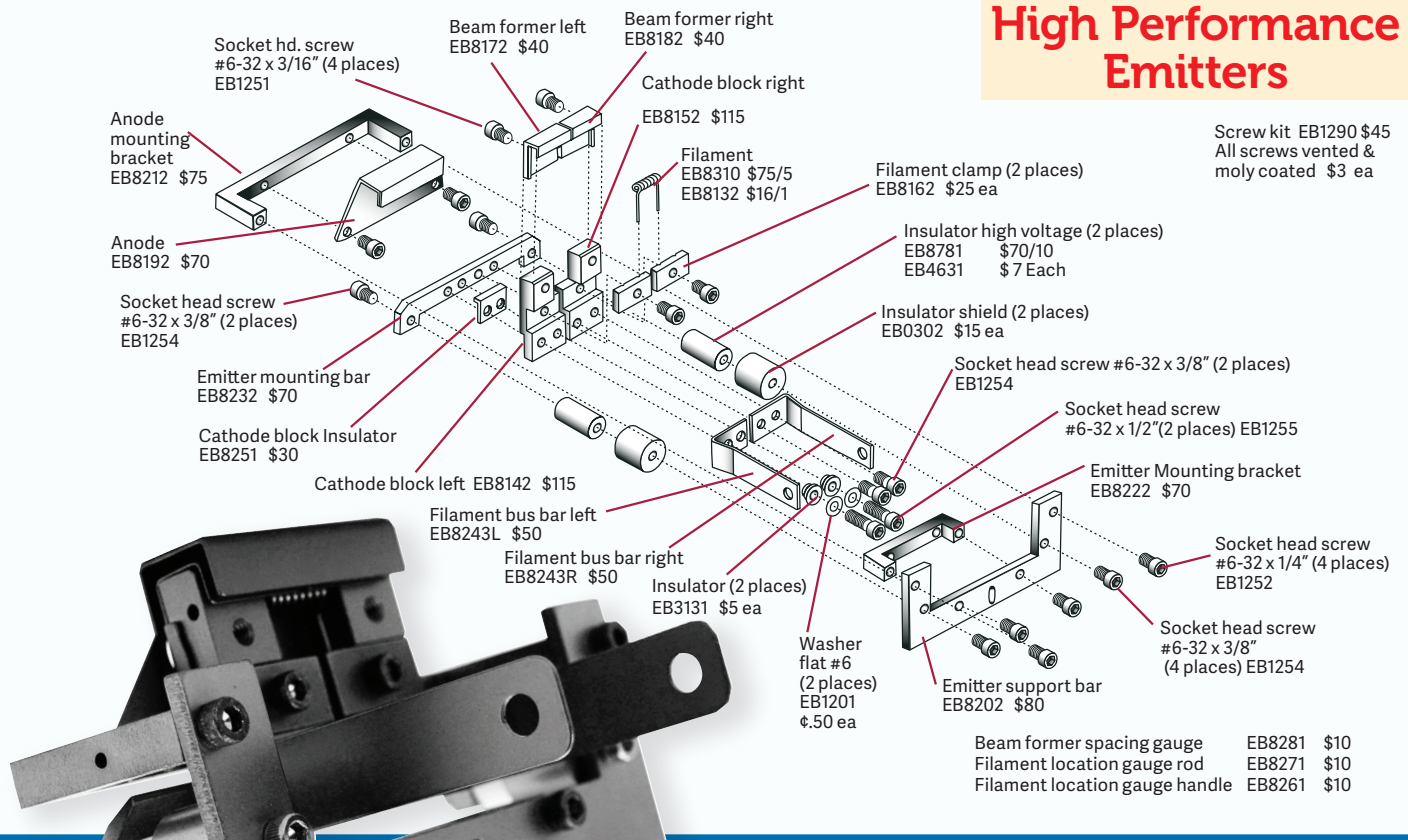

High-Performance Emitter Parts

| | TEMESCAL | Fil-Tech | |
|---------------------------|-------------|----------|------|
| Anode | 0916-8192-0 | EB8192 | \$75 |
| Anode Mounting Bracket | 0916-8212-0 | EB8212 | 75 |
| Beam Former, left | 0916-8172-0 | EB8172 | 40 |
| Beam Former, Right | 0916-8182-0 | EB8182 | 40 |
| Beam Former Spacing Gauge | 0916-8281-0 | EB8281 | 10 |
| Cathode Block Insulator | 0916-8251-0 | EB8251 | 30 |
| Cathode Block, Left | 0916-8142-0 | EB8142 | 115 |
| Cathode Block, Right | 0916-8152-0 | EB8152 | 115 |
| Emitter Mounting Bar | 0916-8232-0 | EB8232 | 70 |
| Emitter Mounting Bracket | 0916-8222-0 | EB8222 | 70 |
| Emitter Support Bar | 0916-8202-0 | EB8202 | 80 |
| Filament Bus Bar, Left | 0916-8243-1 | EB8243L | 50 |
| Filament Bus Bar, Right | 0916-8243-2 | EB8243R | 50 |
| Filament Clamp | 0916-8162-0 | EB8162 | 25 |
| Emitter Assembly | 0916-8294-0 | EB8294 | 825 |

Electromagnetic Coil

TEMESCAL

0312-6923-0 | \$1,690

Fil-Tech

EB6923 | \$1,500

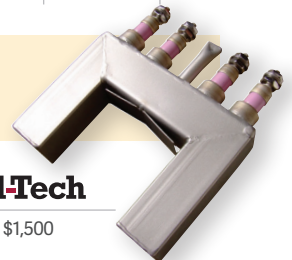

Filaments



| TEMESCAL | SuperSource® | 0317-6871-0 | EB6871 | \$74 |
|-------------|-------------------|----------------|----------|--------|
| | | 0303-9351-0 | EB9351 | 15/1 |
| | | 0515-5441-0 | EB5441 | 74 |
| | High Performance® | 0916-8310-0 | EB8310 | 75 |
| | | 0916-8132-0 | EB8132 | 16/1 |
| TELEMARK | Multi Pocket | 273-0001-1 | EB0001 | 74 |
| THERMIONICS | Multi Pocket | 273-0002-1 | EB0002 | 74 |
| | | A112153 | EB6871 | 74 |
| SATISLOH | SuperSource | A7500823P-122M | EB6871 | 74 |
| | | A7500823P-005M | EB6871-1 | 80 |
| | S Type | A7500336J-003M | EB8483-5 | 290/20 |
| SLOAN | 270 Gun | 126-710 | EB7910 | 150 |
| LEYBOLD | Hooked Ends | 10-094-226 | EB4226 | 190/10 |
| | | 84830-005 | EB8483-5 | 290/20 |
| JEOL | Half moon | 812180313 | EB0313 | 65 |

All filaments 5 per box except otherwise indicated.

Telemark parts can be ordered using Temescal part numbers.

Do you have a **MDC Vacuum Products e-vap®** source with a HF emitter assembly?
Call us for replacement emitter assemblies and component parts

Crucibles

All Crucibles and Covers are OFHC for Temescal and Telemark electron beam guns.

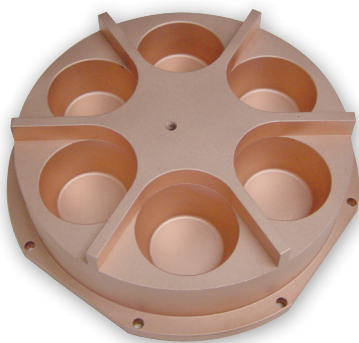

| SIZE | TEMESCAL | | Fil-Tech | |
|----------------|-------------|---------|----------|---------|
| 4x15cc Pockets | 0715-8444-0 | \$1,995 | EB8444 | \$1,700 |
| 6x15cc Pockets | 0715-8504-0 | 1,995 | EB8504 | 1,800 |
| 4x25cc Pockets | 0715-8454-0 | 1,995 | EB8454 | 1,700 |

| SIZE | TELEMARK | | Fil-Tech | |
|----------------|------------|---------|----------|---------|
| 6x15cc Pockets | 271-0255-3 | \$2,250 | EB0255-3 | \$1,900 |
| 4x25cc Pockets | 271-0220-3 | 2,250 | EB0220-3 | 1,900 |
| 6x25cc Pockets | 271-0257-3 | 2,250 | EB0257-3 | 1,900 |

All high water flow

Crucible Covers

| SIZE | TEMESCAL | | Fil-Tech | |
|-----------|-------------|-------|----------|-------|
| 4 Pockets | 0715-8143-0 | \$675 | EB8143 | \$600 |
| 6 Pockets | 0715-8153-0 | 780 | EB8153 | 650 |

| SIZE | TELEMARK | | Fil-Tech | |
|-----------|------------|---------|----------|-------|
| 4 Pockets | 271-0073-1 | \$1,150 | EB0073 | \$545 |
| 6 Pockets | 271-0074-1 | 1,150 | EB0074 | 545 |

Silicon Dioxide

High purity SiO₂ specifically designed for electron beam evaporation.

SPECIFICATIONS

| | | | |
|--------|----------|------------------|------------------|
| Purity | 99.99% | Melting point | 1713°C |
| Form | Granular | Refractive index | n/d 1.46 @500 nm |

ORDERING INFORMATION

| | | |
|----------|------------------------|--------------|
| EM0024-5 | 2-4 Granular size (mm) | \$100 (500g) |
|----------|------------------------|--------------|

**ALL ITEMS
IN STOCK**

Crucible Liners

Fil-Tech supplies 4cc, 7cc, 15cc, 25cc, 30cc and 40cc crucible liners for Temescal and Telemark electron beam gun crucibles. Available in Graphite, Tungsten, Molybdenum, Aluminum Oxide, Boron Nitride, Copper, Intermetallic, Tantalum, and Vitreous Carbon. We can also fabricate custom liners for your e-beam guns.



| | SIZE | REMARKS | TEMESCAL | TELEMARK | Fil-Tech | |
|------------|------|----------|-------------|------------|----------|-------|
| GRAPHITE | 7CC | | 0627-6172-1 | 271-7007-1 | EC0007-1 | \$40 |
| | 15CC | | 0627-6172-3 | 271-7015-1 | EC0015-1 | 50 |
| | 25CC | 4 Pocket | 0627-6172-5 | 271-7025-1 | EC4025-1 | 60 |
| | 25CC | 6 Pocket | N/A | 271-7025-2 | EC6025-1 | 65 |
| | 30CC | W/Web | N/A | 271-7030-1 | ECW030-1 | 75 |
| | 30CC | W/O Web | N/A | 271-7030-2 | EC0030-1 | 75 |
| | 40CC | | 0627-6172-7 | 271-7040-1 | EC0040-1 | 80 |
| TUNGSTEN | 7CC | | 0627-6152-1 | 271-7008-9 | EC0007-2 | \$180 |
| | 15CC | | 0627-6152-3 | 271-7016-9 | EC0015-2 | 185 |
| | 25CC | 4 Pocket | 0627-6152-5 | 271-7026-9 | EC4025-2 | 255 |
| | 25CC | 6 Pocket | 0627-6152-6 | 271-7027-9 | EC6025-2 | 280 |
| | 30CC | W/Web | N/A | N/A | ECW030-2 | 195 |
| | 30CC | W/O Web | N/A | N/A | EC0030-2 | 300 |
| | 40CC | | 0627-6152-7 | 271-7041-9 | EC0040-2 | 400 |
| MOLYBDENUM | 7CC | | 0627-6162-1 | 271-7007-3 | EC0007-3 | \$110 |
| | 15CC | | 0627-6162-3 | 271-7015-3 | EC0015-3 | 100 |
| | 25CC | 4 Pocket | 0627-6162-5 | 271-7025-3 | EC4025-3 | 155 |
| | 25CC | 6 Pocket | N/A | 271-7025-4 | EC6025-3 | 180 |
| | 30CC | W/Web | N/A | 271-7030-3 | ECW030-3 | 185 |
| | 30CC | W/O Web | N/A | 271-7030-4 | EC0030-3 | 180 |
| | 40CC | | 0627-6162-7 | 271-7040-3 | EC0040-3 | 190 |

MARK II Cathode Tip & Keeper

VEECO

| | | | Fil-Tech | |
|---------------------|-----------|-------|----------|-------|
| MARK II Cathode Tip | B17968/SP | \$380 | IS17968 | \$315 |
| MARK II Keeper | A17973 | \$157 | IS17973 | \$70 |



order online:
www.filtech.com

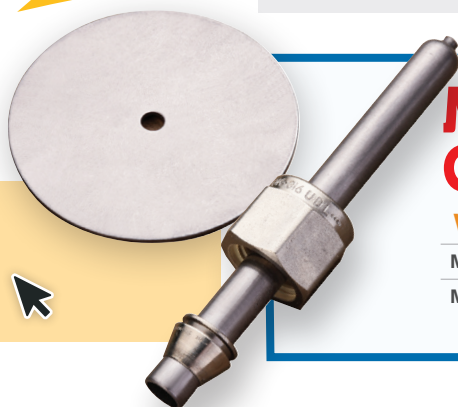

ION SOURCE PARTS

- Veeco Mark I & Mark II • Ion Tech
- Satisloh • Kaufman & Robinson

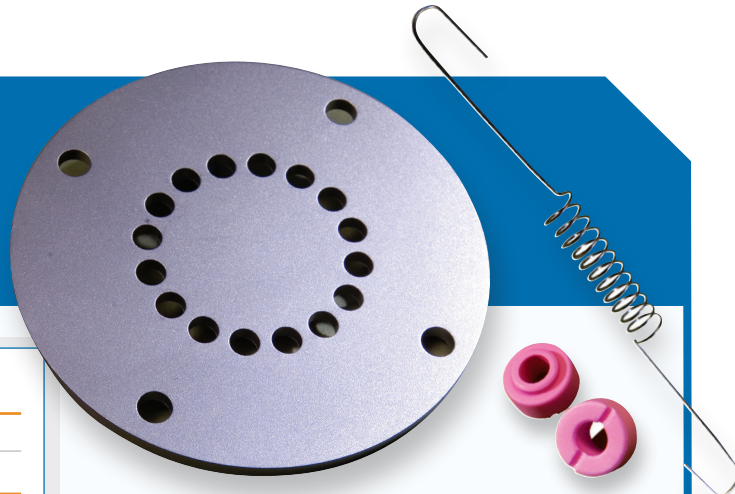

Replacement parts for Veeco Mark I and II, Ion Tech, Satisloh and Kaufman & Robinson ion source equipment. Filaments, insulators, anodes, gas distributors, cathode tips, keepers and other parts are drop-in replacements for the competitive parts listed and offered from stock at competitive pricing.

Filaments

| | VEECO | SATISLOH | Fil-Tech | |
|-------------------------------|--------------|----------|----------------|-----------------|
| MARK I | A30274 | \$7.20 | A7500800Q-131M | IS30274 \$6 |
| MARK II | A16962 | 7.60 | A7500800Q-101M | IS16962 5 |
| VEECO / ION TECH | | | | Fil-Tech |
| 3&5cm Cathode | 0503-107 | \$50 | | IS3107 \$12 |
| 3cm Neutralizer | 0503-063 | | | IS3063 12 |
| 5cm Neutralizer | 0505-001-003 | 64 | | IS1003 6 |
| KAUFMAN & ROBINSON | | | | Fil-Tech |
| EH1000 | HFL-A01 | | | ISKRLA01 3.50 |
| EH200 & EH400 | HFM-A01 | | | ISKRMA01 3 |

Insulators

| | VEECO | SATISLOH | Fil-Tech | |
|-----------------------------------|------------|--------------------|----------------|-----------------|
| MARK I | 1451001 | \$ 7.82 | A7500800Q-136M | IS1001 \$6 |
| MARK I & II | 10-32M | | A7500800Q-167M | IS1032 6.50 |
| | 10-32F | | A7500800Q-134M | IS1032F 10 |
| | 6-32F | | | IS0632F 12 |
| | 6-32M | | | IS0632M 8 |
| | 6-MS | 8.50 | | IS06MS 8 |
| | 1/4-20M | 15.60 | | IS2520M 12 |
| | 1/4-20F | 15.60 | | IS2520F 12 |
| VEECO/ION TECH 3 & 5CM | | | | Fil-Tech |
| | 0500-035 M | \$7.35 | | IS0035 \$6 |
| | 0500-036 F | 9.80 | | IS0036 7 |
| | 0500-037 M | 8.50 | | IS0037 7 |
| KAUFMAN & ROBINSON | | | | Fil-Tech |
| INSULATORS | 10-32M | Insulator | | IS1032 \$6.50 |
| | 10-32M-2 | Insulator | | IS0035 8 |
| | 6-32M | Insulator | | IS0632M 8 |
| | 1/3-20m-1 | Insulator | | IS2520M 12 |
| REFLECTOR | ISKR1012G | Graphite Reflector | | EH10-12-CG 75 |

Anodes

| | VEECO | SATISLOH | Fil-Tech | |
|----------------|--------------------|----------|----------------|---------------|
| MARK I | B18003-1 Graphite | \$77 | A7500800Q-132M | IS18003G \$65 |
| | B18003-2 Stainless | 57 | A7500800Q-133M | IS18003S 55 |
| MARK II | B16933-1 Graphite | 196 | A7500800Q-175M | IS16933G 160 |
| | B16933-2 Stainless | 144 | A7500800Q-166M | IS16933S 85 |

Mark II Parts

| Mark II | Description | Fil-Tech | |
|---------|----------------------|----------|-------|
| B16923 | Pole Piece, Outer | IS16923 | \$202 |
| B16927 | Alnico-5 Magnet | IS16927 | 67 |
| B16928 | Support Plate | IS16928 | 361 |
| B16929 | Baffle | IS16929 | 26 |
| B16930 | Spacer | IS16930 | 28/3 |
| B16932 | Support, Back Anode | IS16932 | 185 |
| B16934 | Support, Front Anode | IS16934 | 198 |
| B16935 | Tie Rod, Short | IS16935 | 38/2 |
| B16936 | Tie Rod, Long | IS16936 | 38/2 |
| B16937 | Cathode Connection | IS16937 | 105/2 |
| B16938 | Anode Connection | IS16938 | 19 |
| B16939 | Support, Cathode | IS16939 | 122/2 |
| B16940 | Knob, Hold Down | IS16940 | 50/2 |
| B16944 | Retainer, Cable | IS16944 | 106/3 |
| B16946 | Cover, Empty Socket | IS16946 | 70 |
| B16947 | Work Station | IS16947 | 100 |
| B29958 | Pin, Alignment | IS29958 | 42/2 |
| B29959 | Screw, Hold Down | IS29959 | 72/2 |
| B29960 | Socket | IS29960 | 298 |
| B29961 | Plug | IS29961 | 395 |

Gas Distributors

| | VEECO | SATISLOH | Fil-Tech | |
|------------------------------|---------------------|----------|----------------|----------------|
| MARK I | B18005-1 Graphite | \$356 | A7500800Q-134M | IS18005G \$100 |
| | B18005-3 Stainless | 75 | A7500800Q-135M | IS18005S 75 |
| | B18005-5 Titanium | 455 | | IS18005T 100 |
| MARK I MODIFIED HOLES | B18005-1A Graphite | | | IS18005G-1 100 |
| | B18005-2A Stainless | | | IS18005S-1 90 |
| | B18005T-1 Titanium | | | IS18005T-1 100 |
| MARK II | B16931-1 Graphite | 554 | A7500800Q-174M | IS16931G 240 |
| | B16931-2 Stainless | 109 | A7500800Q-154M | IS16931S 65 |
| | B16931-5 Titanium | 209 | A7500800Q-202M | IS16931T 100 |

Call 800-743-1743 For a complete listing of Mark I, I+, II and II+ parts.

Thermocouple Gauge Tubes

For semiconductor and vacuum applications. All of our thermocouples are drop-in replacements for the OEM gauges offered at a savings.

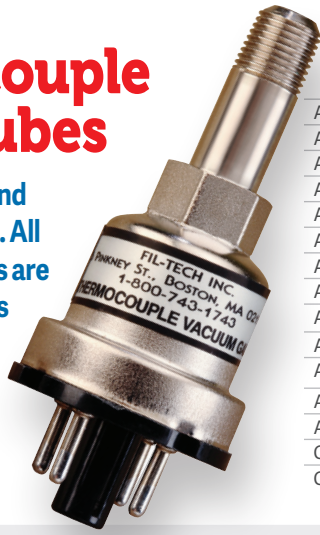

| COMPETITION | | Fil-Tech | |
|-------------|----------------|-----------|-------|
| Agilent | F0472301 | TC531 | \$ 68 |
| Agilent | F0472310 | TC531VCR | 145 |
| AMAT | F2518001 | TC004V | 52 |
| AMAT | 3310-01012 | TC531 | 68 |
| AMAT | 3310-01074 | TC531VCR | 145 |
| AMAT | 3310-00236 | TC6M | 68 |
| AMAT | 3310-01071 | TC6MVCR | 135 |
| Axcelis | 3300008 | TC004V | 52 |
| Axcelis | 33001330 | TC004KF16 | 145 |
| Axcelis | 33000002 | TC002 | 110 |
| Axcelis | 33001009 | TC3309 | 70 |
| Axcelis | 7435-0001-0001 | TC7435-1 | 85 |
| Axcelis | 7435-0003-0001 | TC7435-3 | 90 |
| CVC | GTC-004 | TC004 | 52 |
| CVC | GTC-036 | TC036 | 60 |

| COMPETITION | | Fil-Tech | |
|-------------|-------------|----------|------|
| Hastings | DV-6M | TC6M | \$68 |
| Hastings | DV-6-VCR | TC6MVCR | 145 |
| Hastings | DV-6-KF16 | TC6MKF16 | 135 |
| Hastings | DV-6-KF25 | TC6MKF25 | 155 |
| Hastings | DV-4D | TC4D | 85 |
| MKS | 270006 | TC6M | 70 |
| MKS | 8112105 | TC6MVCR | 145 |
| MRC | 405052 | TC520 | 105 |
| Novellus | 60-00005-00 | TC6M | 70 |
| Novellus | 60-00180-00 | TC6MKF25 | 155 |
| Temescal | 6920-4263-0 | TC6M | 70 |
| Thermionics | 6343-004M | TC004V | 52 |



InstruTech® Convection Gauges

We offer the complete InstruTech line of low cost, drop-in plug compatible replacements for Convectron® gauges. Call for pricing.



| FITTING | HORNET 400 Fil-Tech | HORNET 401 Fil-Tech | HORNET 402 Fil-Tech |
|-----------------|---------------------|---------------------|---------------------|
| NW16KF | IGM400YBX \$811 | IGM401YBD \$988 | IGM402YBD \$1,100 |
| NW25KF | IGM400YCX 824 | IGM401YCD 1,011 | IGM402YCD 1,130 |
| NW40KF | IGM400YDX 835 | IGM401YDD 1,025 | IGM402YDD 1,141 |
| 2 3/4CF | IGM400YFX 846 | IGM401YFD 1,034 | IGM402YFD 1,135 |
| 1/2" Cajon 8VCR | IGM400YHX 835 | IGM401YHD 1,025 | IGM402YHD 1,141 |

*275071: Novellus 27-229979
 **275203: Axcelis 33000317
 ***275185: AMAT 275262
 Novellus/Lam 77-1090453-001
 Novellus 60-00055-00

| FITTING | WORKER BEE | MKS | Fil-Tech | SUPER BEE | MKS | Fil-Tech | STINGER | MKS | Fil-Tech |
|----------|------------|-----------|----------|-----------|--------|----------|-----------|--------|----------|
| 1/8" NPT | CVG101GA | 275071* | \$132 | CVM201GAA | 275850 | \$499 | CVM211GAA | 275800 | \$347 |
| NW16KF | CVG101GB | 275203** | 154 | CVM201GBA | 275865 | 523 | CVM211GBA | 275806 | 365 |
| NW25KF | CVG101GC | 275196 | 171 | CVM201GCA | 275867 | 540 | CVM211GCA | 275807 | 375 |
| NW40KF | CVG101GD | 275316 | 182 | CVM201GDA | 275858 | 555 | CVM211GDA | 275808 | 386 |
| 1/4" VCR | CVG101GG | 275185*** | 171 | CVM201GGA | 275851 | 540 | CVM211GGA | 275801 | 375 |

Thermocouple Controllers

DIGITAL PANEL MOUNT Fil-Tech

| | | |
|--------|------------|-------|
| TC801 | TC531 Tube | \$600 |
| TC215H | TC6M Tube | 755 |

DIGITAL PANEL MOUNT SINGLE STATION

| | | |
|--------|------------|-----|
| TC101D | TC531 Tube | 435 |
| TC201D | TC6M Tube | 435 |

DIGITAL CABINET MOUNT SINGLE STATION

| | | |
|---------|------------|-----|
| TC101DC | TC531 Tube | 495 |
| TC101DC | TC6M Tube | 495 |



MG15 Multi Gauge Ion Controller

Supports 4 Active & up to 3 Passive Gauge

Our MG15 ion gauge controller can support up to 4 active gauges and 3 passive gauges, extending the measurement range to 2 x 10⁻¹² mbar. The MG15 supports all Bayard Alpert style gauges, Baratron, UHV nude gauges and others. It can be remotely controlled by one of its available interfaces and has 10 individually programmable set points with threshold and hysteresis functions. The MG15 can support four active gauges and up to three passive gauges. Price varies with 1, 2 or 3 passive gauges.

POR



Ion Implantation

| AXCELIS | DESCRIPTION | Fil-Tech | |
|----------------|---------------------------|----------|-------|
| 3300002 | 3/4" Glass, Twin Tungsten | G75PT | \$155 |
| 7631-0001-0002 | 3/4" Kovar, Twin Tungsten | G75KT | 175 |
| 3300008 | Thermocouple Gauge | TC004V | 52 |

AMAT

| | | | |
|------------|--|----------|-------|
| 5300019 | 1" Glass, Twin Tungsten | G100PT | \$158 |
| K7360301 | 1" Glass, Twin Tungsten | G100PT | 158 |
| 4053050 | 1" Kovar, Twin Tungsten, 2 3/4" Flange | G100KTF | 220 |
| 3310-90003 | 1" Glass, Twin Tungsten | G100PT | 158 |
| F2518001 | Thermocouple Gauge | TC004V | 52 |
| 3310-00236 | Thermocouple Gauge | TC6M | 68 |
| 3310-01071 | Thermocouple Gauge VCR | TC6MVCR | 145 |
| 3310-01012 | Thermocouple Gauge | TC531 | 68 |
| 3310-01074 | Thermocouple Gauge VCR | TC531VCR | 145 |

LAM/NOVELLUS

| | | | |
|---------------|---|----------|-----|
| 27-229-700-00 | 1" Glass, Iridium, Pt Coated, Broad Range | G8136P/1 | 220 |
| 60-00005-00 | Thermocouple Gauge | TC6M | 68 |
| 60-00180-00 | Thermocouple Gauge VCR | TC6MVCR | 145 |

SEN

| | | | |
|---------|---------------------------|-----------|-----|
| 33S0298 | 3/4" Glass, Twin Tungsten | G75PT-02S | 165 |
|---------|---------------------------|-----------|-----|

Vacuum Applications

| AGILENT | DESCRIPTION | PRICE | Fil-Tech | |
|----------|---|-------|----------|-----|
| K2471301 | 1" Glass, Iridium | 210 | G100P | 188 |
| K2471302 | 1" Kovar, Iridium | 235 | G100K | 210 |
| K2471303 | 1" Kovar, Iridium, 2 3/4" Flange | 296 | G100KF | 260 |
| K2471304 | 3/4" Glass, Iridium | 200 | G75P | 174 |
| K2471305 | 3/4" Kovar, Iridium | 224 | G75K | 202 |
| K7360301 | 1" Glass, Twin Tungsten | 175 | G100PT | 158 |
| K7360302 | 1" Kovar, Twin Tungsten | 207 | G100KT | 176 |
| K7360303 | 3/4" Glass, Twin Tungsten | 175 | G75PT | 155 |
| K7360304 | 3/4" Kovar, Twin Tungsten | 207 | G75KT | 175 |
| K7360307 | 1" Kovar, Twin Tungsten, 2 3/4" Flange | 259 | G100KTF | 220 |
| K2500301 | 1" Glass, Iridium, Pt Coated, Broad Range | 290 | G8136P/1 | 220 |
| K2500302 | 1" Kovar, Iridium, Pt Coated, Broad Range | 320 | G8136K/1 | 255 |
| K2500303 | 1" Kovar, Iridium, Pt Coated, 2 3/4" Flange, BR | 366 | G8136F | 285 |

MKS

| | | | | |
|--------|------------------------------------|-------|----------|-----|
| 274002 | 3/4" Glass, Iridium | | G75P | 174 |
| 274003 | 3/4" Kovar, Iridium | | G75K | 202 |
| 274005 | 1" Glass, Iridium | | G100P | 188 |
| 274006 | 1" Kovar, Iridium | \$273 | G100K | 210 |
| 274007 | 3/4" Kovar, Iridium, 2 3/4" Flange | 279 | G75KF | 260 |
| 274008 | 1" Kovar, Iridium, 2 3/4" Flange | 279 | G100KF | 260 |
| 274012 | 3/4" Glass, Twin Tungsten | | G75PT | 155 |
| 274013 | 3/4" Kovar, Twin Tungsten | | G75KT | 175 |
| 274015 | 1" Glass, Twin Tungsten | 163 | G100PT | 158 |
| 274016 | 1" Kovar, Twin Tungsten | 179 | G100KT | 176 |
| 274032 | 1" Kovar, Iridium, KF25 Flange | 315 | G100KF25 | 260 |

ANELVA

| | | | | |
|--------------------|---------------------------|--|-------|-----|
| 33-437-0025/UDG-1S | 15mm Glass, Twin Tungsten | | G59PT | 220 |
| BRG-1B | 15mm Glass, Iridium | | G59P | 220 |

MRC

| | | | | |
|---------|----------------------------|--|-------|-----|
| 4050300 | .709" Glass, Twin Tungsten | | G71PT | 175 |
|---------|----------------------------|--|-------|-----|

Ionization & Thermocouple Gauge Tubes



All Fil-Tech ionization gauge tubes are identical or functionally equivalent to the competitive tubes listed. They are all manufactured by two companies and privately labeled. See comparative prices for savings.

INFICON Vacuum Gauges

INFICON
authorized distributor

Fil-Tech is an authorized distributor of INFICON vacuum gauges. We supply INFICON's Pirani Standard, Pirani Standard Advanced, Pirani Capacitance Diaphragm, Bayard-Alpert, Bayard-Alpert Pirani, Bayard-Alpert Pirani Capacitance Diaphragm, Inverted Magnetron Pirani, and Penning Cold Cathode gauges. Choose your INFICON gauge and call us for best pricing.



order online:
www.filtech.com



Leak Detector Filaments

Fil-Tech's LD10's are drop-in replacements for the OEM part. Our filament is welded into the slotted posts for greater reliability and longer life.



LD7



LD10

| FILAMENT | ALCATEL | Fil-Tech | |
|------------------|---------|----------|-------|
| Filament | 053146 | LD10 | \$130 |
| Collector Single | 083485 | LD11 | 32 |
| Collector Double | 101127 | LD12 | 35 |

| FILAMENT | AGILENT | Fil-Tech Repair Exchange | |
|----------|----------|-----------------------------|------|
| Tungsten | 82850301 | LD7RE | \$50 |
| Iridium | 82850302 | LD8RE | 105 |

Nude Gauges & Filaments

Visit www.filtech.com for a complete listing of our nude gauges and replacement filaments.

AGILENT • AMAT • MKS

Bayard Alpert Gauges/Pin Guards

Flange 2 3/4" • Header Ceramic to Metal Seal • Degas E-Beam Only

| MKS | | AMAT | DESCRIPTION | Fil-Tech | |
|--------|-------|------------|-------------------------------|----------|-------|
| 274028 | \$552 | | Iridium Single | GB20IR | \$440 |
| 274043 | 625 | 3310-01081 | Iridium Single With Pin Guard | GB43IR | 620 |



UHV Gauges/Pin Guards

Flange 2 3/4" • Header Ceramic to Metal Seal • Degas E-Beam Only

| MKS | | DESCRIPTION | Fil-Tech | |
|--------|-------|-----------------------------------|----------|-------|
| 274022 | \$552 | Tungsten Dual | GU21T | \$410 |
| 274023 | 594 | Iridium Dual | GU21IR | 485 |
| 274050 | 562 | Tungsten Dual, NW40KF | GU50T | 530 |
| 274041 | 625 | Tungsten Dual With Pin Guard | GU41T | 530 |
| 274042 | 657 | Iridium Dual With Pin Guard | GU42IR | 565 |
| 274057 | 641 | Tungsten Dual, NW40KF w/Pin Guard | GU57T | 540 |

AGILENT

| | | | | |
|---------|-----|---------------|--------|-----|
| 9715007 | 672 | Iridium Dual | GU24IR | 600 |
| 9715008 | 652 | Tungsten Dual | GU24T | 600 |

Replacement Filaments

| AGILENT | | DESCRIPTION | Fil-Tech | |
|---------|-------|---------------|----------|------|
| 9710018 | \$117 | Tungsten Dual | GF18 | \$50 |
| 9710028 | 232 | Iridium Dual | GF28 | 105 |

MKS

| | | | | |
|--------|-----|----------------|------|-----|
| 274024 | 189 | Tungsten Dual | GF24 | 78 |
| 274025 | 221 | Tungsten Dual | GF25 | 105 |
| 274029 | 189 | Iridium Single | GF29 | 105 |

One filament per box

CALIBRATED HELIUM LEAKS

| | NEW | Fil-Tech | | RECALIBRATION |
|-----|--------------|----------|------------------------------|---------------|
| CL7 | 10-7ccHe/sec | \$525 | Certification | \$375 |
| CL8 | 10-8ccHe/sec | 550 | NIST Traceable Certification | |

Fil-Tech Fluid vs TorrLube

Fil-Tech Fluid dramatically increases bearing life in vacuum and semiconductor processes by reducing friction. It has exceptional lubricating properties for sliding and rotating applications to 10⁻⁸ torr. Fil-Tech Fluid functions in a wide temperature range (-20°C to 260°C) and is chemically inert in the presence of most semiconductor gases such as fluorine at 200°C and trifluoride at 50°C.



| ITEM | SIZE | TORRLUBE® | Fil-Tech FLUID™ |
|--------|-----------------|-----------|--------------------|
| FTF001 | 1 cc Syringe | \$112 | \$100 |
| FTF003 | 3 cc Syringe | 247 | 275 |
| FTF100 | 2-50 cc Bottles | 1,280 | 1,100 |

Diffusion Pump Silicones

All Fil-Tech's fluids are the functional equivalent to Dow Corning's DC702, DC704, and DC705, respectively. They can be mixed and/or reprocessed together in any portion with their respective counterpart. Fil-Tech sells silicones!

FIL-TECH FT702, FT704 AND FT705 SILICONES REPLACE THE NO-LONGER-AVAILABLE DOW CORNING DC702, DC704 AND DC705 SILICONES

FT702 Phenylmethylsiloxane

is an economical general purpose silicone fluid for pumping large gas loads with thermal stability and oxidation resistance. Vacuum 10-5 to 10-7 torr.

FT704 Tetramethyltetraphenyltrisiloxane

is a single component fluid extensively used for applicators requiring rapid pump down of large gas loads. For performance and economics, your best choice. Vacuum 10-5 to 10-8 torr.

FT705 Pentaphenyltrimethyltrisiloxane

is a single component fluid for ultra high and ultra clean vacuums. For lowest ultimate pressure, your best choice. Higher resistance to crystallization. Vacuum 10-5 to 10-10 torr.



| FT702 | NEW | REPROCESSING |
|--------------|-------|--------------|
| 1 Gallon | \$440 | \$195 |
| 5 Gallon | 2,000 | |
| FT704 | | |
| 500 cc | \$90 | |
| 1 Gallon | 550 | 195 |
| 5 Gallon | 2,500 | |
| FT705 | | |
| 500 cc | \$140 | |
| 1 Gallon | 800 | 200 |
| 5 Gallon | 3,800 | |



Call Fil-Tech at 800-743-1743 for a free DOT approved pail to collect your used fluid for remanufacture.

TRADEMARKS

Fil-Tech®

OTHER TRADEMARK OWNERS

- Agilent® Agilent Technologies, Inc.
- Alcatel® Alcatel Vacuum Technology
- AMAT® Applied Materials, Inc.
- Axcelis® Axcelis Technologies, Inc.
- Chemours® The Chemours Company
- Convectron® MKS Instruments
- Dow Corning® Dow Corning Corp.
- CTI/Brooks® Brooks Automation, Inc.
- Hastings® Teledyne Technologies, Inc.
- High Performance® Ferrotec Corp.
- INFICON®
Advanced Adhesion Alloy®
Longer Life Gold®
Quality Crystals®
Stress Relieving Alloy®
- InstruTech® InstruTech
- Intellemetrics® Intellevation Ltd.
- Ion Tech® Veeco Instruments, Inc.
- Kaufman & Robinson® Kaufman & Robinson
- Krytox® The Chemours Company FC, LLC
- Lam® Lam Research Corporation
- Leybold® Oerlikon Leybold Vacuum
- Maxtek® INFICON
- MKS® MKS Instruments
- Novellus® Novellus Systems, Inc.
- Phelps® Phelps Electronic, Inc.
- Q-Sense® Biolin Scientific Holding, AB
- Santovac® Arch Technology Holding, LLC
- Satisloh® Satisloh GmbH
- Sloan® Veeco Instruments, Inc.
- SuperSource® Ferrotec Corp.
- Telemark® Telemark
- Temescal® Ferrotec Corp.
- Thermionics® TLI Enterprises, Inc.
- TorrLube® The Torr Lube Company, LLC
- ULVAC® ULVAC Technologies, Inc.
- Umicore® Umicore
- Unaxis® OC Oerlikon Corp., AG
- Veeco® Veeco Instruments, Inc.
- Windows® Microsoft, Inc.



SANTOVAC 5

Polyphenyl Ether Diffusion Pump Fluid

SANTOVAC® 5 will provide vacuums in the 10-10 torr range with exceptionally low vapor pressure and backstreaming. It is excellent for applications that must be free of silicones or those requiring ultra high, clean vacuums.

| | | |
|------------------|----------|-------|
| SANT5-006 | 65 cc | \$240 |
| SANT5-01 | 100 cc | 325 |
| SANT5-05 | 500 cc | 1,245 |
| SANT5-1 | 1 Gallon | 7450 |



order online: www.filtech.com



MECHANICAL PUMP FLUIDS

FT19

Molecularly distilled hydrocarbon fluid for non-corrosive applications. FT19 works well for all mechanical pumps.

| SPECIFICATIONS | | SIZES | PRICE |
|-----------------------|------------------|-----------|-------|
| Vapor Pressure @ 25°C | 1 x 10-5 torr | 1 Gallon | \$40 |
| Viscosity @ 40°C | 54 cst (251 SUS) | 5 Gallon | 130 |
| Viscosity @100°C | 8 cst (52.7 SUS) | 55 Gallon | 1,175 |

FT20

Doubly distilled hydrocarbon fluid for corrosive or reactive applications. Ideal for direct drive and belt driven mechanical pumps and also suitable for diffusion pump applications.

| SPECIFICATIONS | | SIZES | PRICE |
|-----------------------|--------------------|-----------|-------|
| Vapor Pressure @ 25°C | 1 x 10-6 torr | 1 Gallon | \$70 |
| Viscosity @ 40°C | 58 cst (269 SUS) | 5 Gallon | 270 |
| Viscosity @100°C | 8.5 cst (54.1 SUS) | 55 Gallon | 2,125 |

FT70

High grade oil with temperature resistance and wear protection with extreme load-carrying capability. FT70 is safe for yellow metals in single stage pumps that run hot.

| SPECIFICATIONS | | SIZES | PRICE |
|-----------------------|------------------|-----------|-------|
| Vapor Pressure @ 25°C | 1 x 10-4 torr | 1 Gallon | \$55 |
| Viscosity @ 40°C | 75 cst (350 SUS) | 5 Gallon | 200 |
| Viscosity @100°C | 9.4 cst (58 SUS) | 55 Gallon | 1,450 |

FT77

Molecularly distilled hydrocarbon fluid for rotary piston pump in non-corrosive applications. It has the high viscosity required for the proper lubrication of piston pumps.

| SPECIFICATIONS | | SIZES | PRICE |
|-----------------------|-------------------|-----------|-------|
| Vapor Pressure @ 25°C | 1 x 10-4 torr | 1 Gallon | \$45 |
| Viscosity @ 40°C | 90 cst (418 SUS) | 5 Gallon | 160 |
| Viscosity @100°C | 10 cst (58.8 SUS) | 55 Gallon | 1,300 |

FT87

Molecularly distilled hydrocarbon for large rotary piston pumps and roots blowers in non-corrosive applications requiring higher viscosity fluids.

| SPECIFICATIONS | | SIZES | PRICE |
|-----------------------|-------------------|-----------|-------|
| Vapor Pressure @ 25°C | 4 x 10-4 torr | 1 Gallon | \$50 |
| Viscosity @ 40°C | 175 cst (800 SUS) | 5 Gallon | 185 |
| Viscosity @100°C | 20 cst (97 SUS) | 55 Gallon | 1,325 |



Fil-Tech stocks hydrocarbon oils for mechanical vacuum pumps in 1, 5 and 55 gallon sizes. Our oils are drop-in replacements for the industry standard fluids for roots blowers, rotary piston, and mechanical vacuum pumps used in corrosive or non-corrosive applications.

Call if you have questions regarding a cross-reference oil for your application.

FT97

Molecularly distilled hydrocarbon for large rotary piston pumps and roots blowers in non-corrosive applications requiring highest viscosity fluids.

| SPECIFICATIONS | | SIZES | PRICE |
|-----------------------|-------------------|-----------|-------|
| Vapor Pressure @ 25°C | 4 x 10-4 torr | 1 Gallon | \$55 |
| Viscosity @ 40°C | 205 cst (950 SUS) | 5 Gallon | 200 |
| Viscosity @100°C | 18 cst (85 SUS) | 55 Gallon | 1,435 |

FTTW

TECHNICAL WHITE

Molecularly distilled hydrocarbon fluid containing no additives. Specifically recommended for mechanical pumps exposed to reactive or corrosive gases. FTTW is the longest lasting hydrocarbon fluid.

| SPECIFICATIONS | | SIZES | PRICE |
|-----------------------|------------------|-----------|-------|
| Vapor Pressure @ 25°C | <1 x 10-6 torr | 1 Gallon | \$65 |
| Viscosity @ 40°C | 56 cst (260 SUS) | 5 Gallon | 270 |
| Viscosity @100°C | 9 cst (55.4 SUS) | 55 Gallon | 2,350 |

KRYTOX VACUUM PUMP FLUIDS



Authorized Distributor of Krytox™, a Brand of The Chemours Company

Krytox® Fluid

Chemours Krytox fluids are totally perfluorinated polyether fluids (PFPE) that are suitable for the harsh environments associated with semiconductor processes. The fluids are chemically inert, thermally stable, oxygen resistant and nonflammable. Available with controlled low vapor pressures and viscosities. Applications include plasma etching, LPCVP and 100% oxygen service.

Remanufacturing Service

Fil-Tech's remanufacturing service restores your contaminated KRYTOX or other PFPE fluids to their original properties at high recovery yields. The cost is a fraction of the price of new fluid. Call for pricing.



| | |
|----------------------------|--------------|
| 1506 | \$370/kg |
| 1514 | 370/kg |
| 1525 | 370/kg |
| 1514XP | 400/kg |
| 1525XP | 400/kg |
| XP Rust preventative fluid | |
| PFPE SOLVENT | |
| KXSOLV-1 | \$600/gallon |

Contact us for quantity discounts.

Call Fil-Tech for a free DOT approved pail to collect your used fluid for remanufacture. 800-743-1743

KRYTOX VACUUM GREASES

Chemours has a series of Krytox (PFPE) vacuum greases suitable for various applications. Your viscosity, temperature and vapor pressure requirements will determine your choice of grease. All Krytox greases are inert and suitable for applications requiring high temperature stability and low vapor pressure. They show excellent resistance to the aggressive environments inherent in the semiconductor industry. Krytox greases are oxygen compatible and hydrocarbon free.

| SPECIFICATIONS | | 2 oz | 8 oz | Kg | TEMPERATURE RANGE | VISCOSITY AT 40°C | VAPOR PRESSURE AT 40°C |
|--|--------|-------|-------|---------|-------------------|-------------------|------------------------|
| Electronic Grade EG Greases | EG2000 | \$124 | \$452 | \$2,240 | -34°/288°C | 240 cSt | 2 x 10-8 torr |
| | EG3000 | 124 | 452 | 2,240 | -29°/316°C | 440 cSt | 6 x 10-9 torr |
| Aerospace 240 Greases (milspec) | 240AB | 250 | 870 | 3,115 | -40°/232°C | 78 cSt | 5 x 10-6 torr |
| | 240AC | 250 | 870 | 3,115 | -34°/288°C | 270 cSt | 8 x 10-8 torr |
| | 240AD | 250 | 870 | 3,115 | -29°/316°C | 500 cSt | 6 x 10-9 torr |
| Low Vapor Pressure Grease | LVP | 124 | 455 | 1,830 | 15°/300°C | 740 cSt | 1 x 10-13 torr |
| General Purpose Greases | GPL202 | 56 | 180 | 616 | -63°/132°C | 15 cSt | Standard Grade |
| | GPL203 | 54 | 172 | 595 | -60°/154°C | 30 cSt | Standard Grade |
| | GPL205 | 54 | 172 | 595 | -36°/204°C | 160 cSt | Standard Grade |
| | GPL206 | 54 | 172 | 595 | -36°/260°C | 243 cSt | Standard Grade |
| | GPL207 | 54 | 172 | 595 | -30°/288°C | 450 cSt | Standard Grade |
| | GPL224 | 54 | 172 | 595 | -51°/179°C | 60 cSt | Anti Corrosion |
| | GPL226 | 54 | 172 | 595 | -36°/260°C | 160 cSt | Anti Corrosion |
| | GPL227 | 54 | 172 | 595 | -30°/288°C | 440 cSt | Anti Corrosion |

KRYTOX GENERAL PURPOSE OILS

Krytox GPL oils are clear, colorless, fluorinated synthetic oils that are non reactive, nonflammable, safe in chemical and oxygen service, and long-lasting.

| | Kg | TEMPERATURE RANGE | VISCOSITY AT 40°C |
|--------|-------|-------------------|-------------------|
| GPL101 | \$630 | -70°/104°C | 7.8 cSt |
| GPL102 | 630 | -63°/132°C | 15 cSt |
| GPL103 | 605 | -60°/154°C | 30 cSt |
| GPL104 | 605 | -51°/179°C | 60 cSt |
| GPL105 | 605 | -36°/204°C | 160 cSt |
| GPL106 | 605 | -36°/260°C | 243 cSt |
| GPL107 | 605 | -30°/288°C | 450 cSt |



Fil-Tech

6 PINCKNEY STREET, BOSTON, MA 02114

Quality & Savings From Stock

Presorted Standard
U.S. Postage
PAID
Boston, MA
Permit No. 54302



Liquid Plating Crystals 2

Quality Crystals and Typical System 2

INFICON Multi-Film Rate Thickness Monitors and Controllers 3

Sensor Heads, Positional Sensor Heads, Bakeable Heads,
QC12 and Feedthroughs 4-5

Electron Beam Gun Replacement Parts 6-7

Crucible Liners, Crucibles and Covers, and Silicon Dioxide 8

Ion Source Replacement Parts 9

Thermocouple Gauges and Controllers, and Convection Gauges 10

Ionization Gauges and INFICON Gauges 11

Nude Gauges and Replacement Filaments 12

Leak Detector Filaments, Calibrated Leaks and Fil-Tech Fluid 12

Diffusion Pump Fluids and Santovac 5 13

Hydrocarbon Fluids and Krytox Oils and Greases 14-15

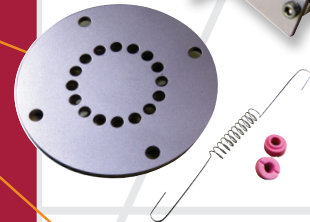
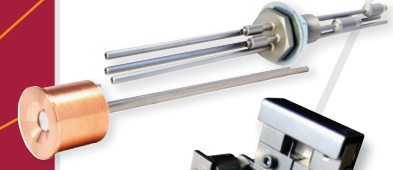

SCAN WITH SMART PHONE FOR OUR FULL CATALOG

SALES HOURS: 8am - 8pm ET TERMS: Net 30 days DELIVERY: Stock F.O.B.: Boston, MA

800-743-1743
617-227-1133

✉ paula@filtech.com

🌐 Online Ordering
www.filtech.com