

# ELECTRON BEAM GUN PARTS

**ALL ITEMS  
IN STOCK**

## Multi-Pocket Emitters

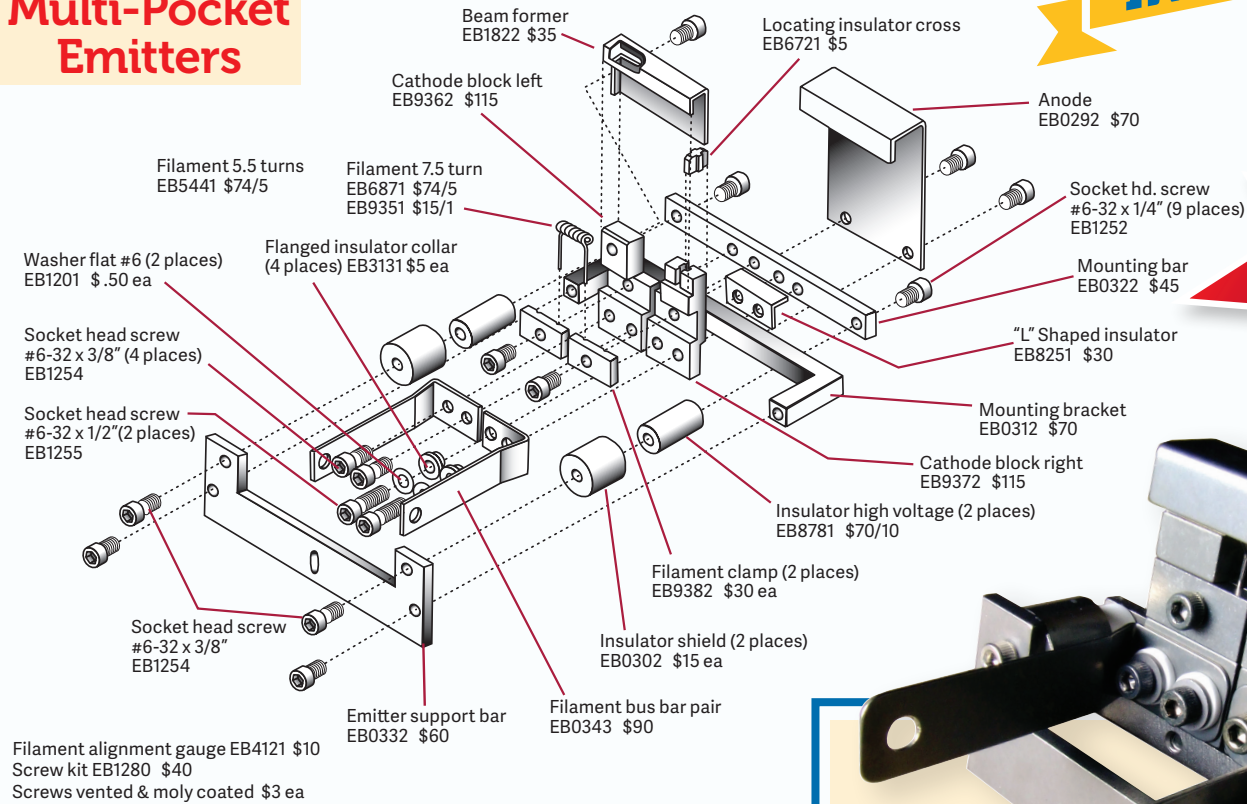

**SHOP  
ONLINE  
NOW!**

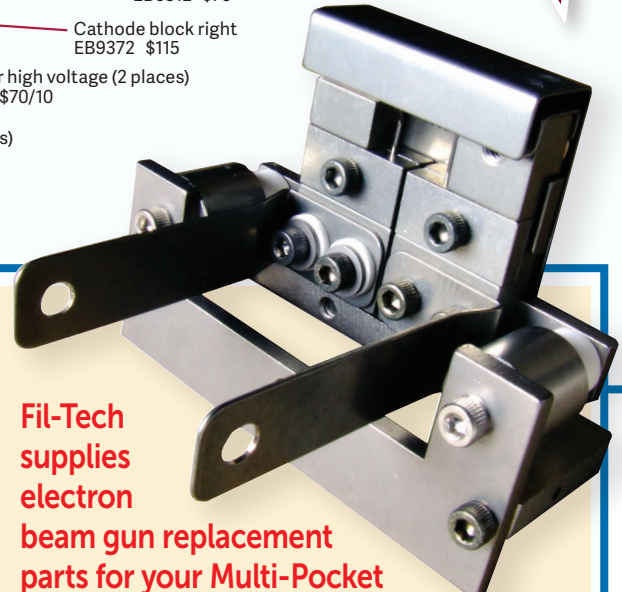

**Fil-Tech supplies electron beam gun replacement parts for your Multi-Pocket and High Performance emitters from Temescal, Telemark, Thermionics, Satisloh, MeiVac, Sloan, and Leybold. Our insulators, filaments, metal parts and electromagnetic coils are drop-in replacements for the listed OEM parts. We can also rebuild your emitters.**

### Multi-Pocket Emitter Parts

	TEMESCAL	TELEMARK	Fil-Tech	
Anode	0204-0292-0	273-0003-1	EB0292	\$75
Beam Former	0415-1822-0	273-0004-2	EB1822	35
Beam Former, Tantalum	0303-9392-0	N/A	EB9392	50
Cathode Block, Left	0303-9362-0	273-0031-1	EB9362	115
Cathode Block, Right	0303-9372-0	273-0032-1	EB9372	115
Emitter Support Bar	0204-0332-0	273-0018-1	EB0332	60
Filament Clamp	0303-9382-0	273-0033-3/273-0033-4	EB9382	30
Filament Bus Bar Set	0204-0343-0	273-0035-1/273-0036-1	EB0343	90
Insulator Shield	0204-0302-0	273-0011-1	EB0302	15
Mounting Bar	0204-0322-0	273-0017-1	EB0322	45
Mounting Bracket	0204-0312-0	273-0019-1	EB0312	70
Seal, Quad Ring	2108-0215-0	N/A	EB0215	2
Seal, RL Gasket	0020-4811-2	N/A	EB4811	6
Emitter Assembly	0204-0284-0	273-0150-1	EB0284	700

### Emitter Assemblies

	TEMESCAL	TELEMARK	Fil-Tech	
Multi Pocket	0204-0284-0	273-0150-1	EB0284 Temescal EB0150M Telemark	\$700
Single Pocket	0304-1914-0	253-0150-1	EB1914	700
High Performance	0916-8294-0	N/A	EB8294	800
Emitter Rebuilding Service*	N/A	N/A	EBREBLD	350

\*Includes glass beading and chemically cleaning all metal parts, replacing filament, screws (all vented), insulators, and reassembling. Metal parts not included.

Insulators	TEMESCAL	TELEMARK	Fil-Tech	
Flanged/Collar	0303-3131-0	273-0006-1	EB3131	\$5
Locating/Cross	0303-6721-0	273-0005-1	EB6721	5
High Voltage	0602-8781-0	273-0010-1	EB8781	70/10
High Voltage	0418-4631-0	273-3010-1	EB4631	7
Cathode Block "L" Shaped	0916-8251-0	273-0008-1	EB8251	30
Temescal and Telemark parts are interchangeable.				
<b>SLOAN</b>	126-116		EB6116	\$22

**High Performance Emitters**

Screw kit EB1290 \$45  
All screws vented & moly coated \$3 ea

**SHOP ONLINE NOW!**

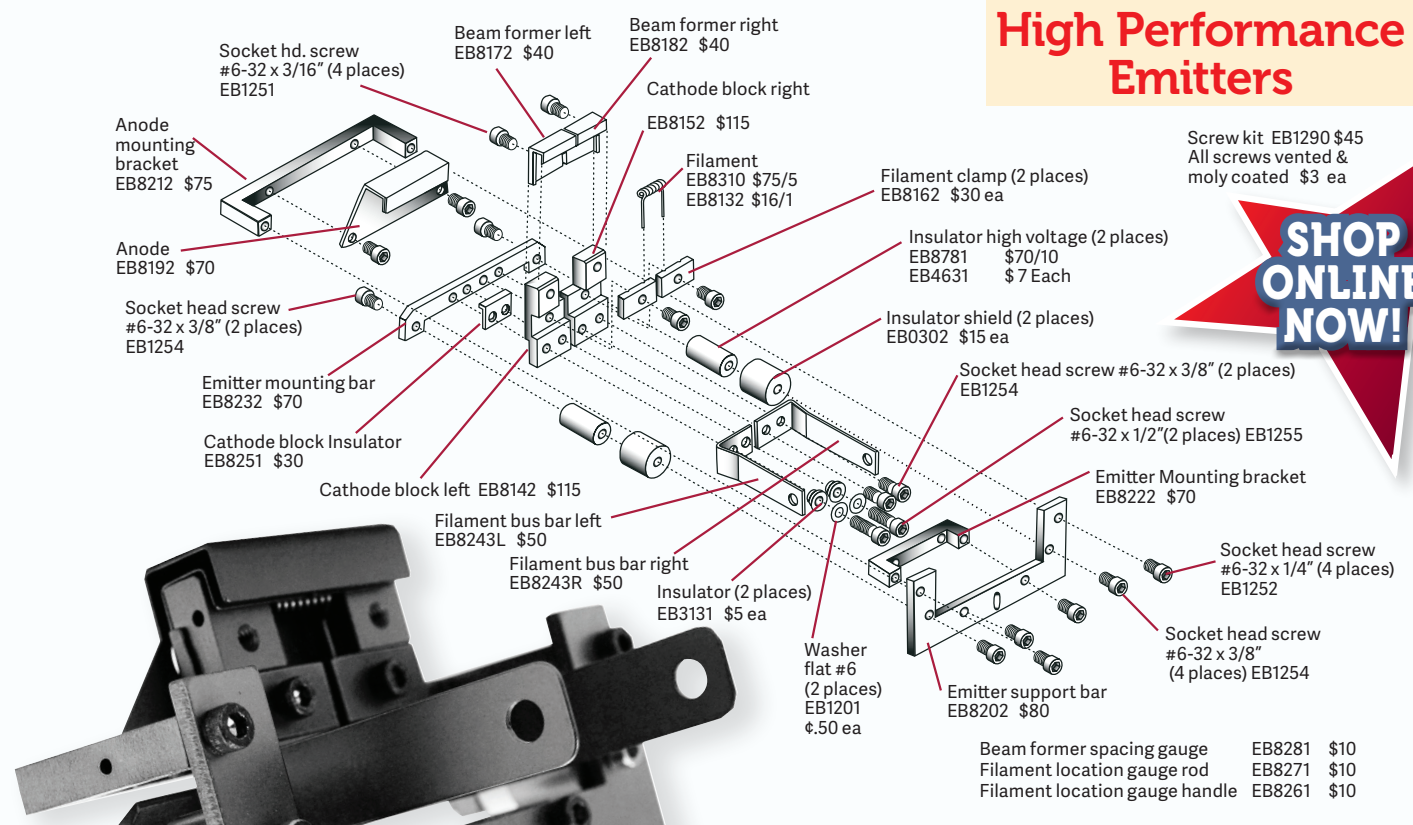

Filaments		Fil-Tech		
TEMESCAL	SuperSource®	0317-6871-0	EB6871	\$74
		0303-9351-0	EB9351	15/1
		0515-5441-0	EB5441	74
	High Performance®	0916-8310-0	EB8310	75
		0916-8132-0	EB8132	16/1
TELEMARK	Multi Pocket	273-0001-1	EB0001	74
THERMIONICS	Multi Pocket	273-0002-1	EB0002	74
		A112153	EB6871	74
SATISLOH	SuperSource	A7500823P-122M	EB6871	74
		A7500823P-005M	EB6871-1	80
	S Type	A7500336J-003M	EB8483-5	290/20
SLOAN	270 Gun	126-710	EB7910	150
LEYBOLD	Hooked Ends	10-094-226	EB4226	190/10
		84830-005	EB8483-5	290/20
JEOL	Half moon	812180313	EB0313	65

All filaments 5 per box except otherwise indicated.

Telemark parts can be ordered using Temescal part numbers.

**High-Performance Emitter Parts**

	TEMESCAL	Fil-Tech	
Anode	0916-8192-0	EB8192	\$75
Anode Mounting Bracket	0916-8212-0	EB8212	75
Beam Former, left	0916-8172-0	EB8172	40
Beam Former, Right	0916-8182-0	EB8182	40
Beam Former Spacing Gauge	0916-8281-0	EB8281	10
Cathode Block Insulator	0916-8251-0	EB8251	30
Cathode Block, Left	0916-8142-0	EB8142	115
Cathode Block, Right	0916-8152-0	EB8152	115
Emitter Mounting Bar	0916-8232-0	EB8232	70
Emitter Mounting Bracket	0916-8222-0	EB8222	70
Emitter Support Bar	0916-8202-0	EB8202	80
Filament Bus Bar, Left	0916-8243-1	EB8243L	50
Filament Bus Bar, Right	0916-8243-2	EB8243R	50
Filament Clamp	0916-8162-0	EB8162	30
Emitter Assembly	0916-8294-0	EB8294	825

**Electromagnetic Coil**

TEMESCAL	Fil-Tech
0312-6923-0	\$1,690
EB6923	\$1,500

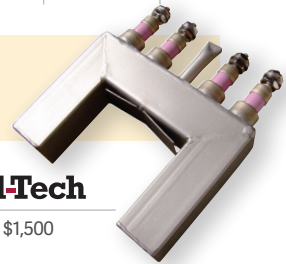

Do you have a **MDC Vacuum Products e-vap®** source with a HF emitter assembly?  
Call us for replacement emitter assemblies and component parts

## Crucibles

All Crucibles and Covers are OFHC for Temescal and Telemark electron beam guns.

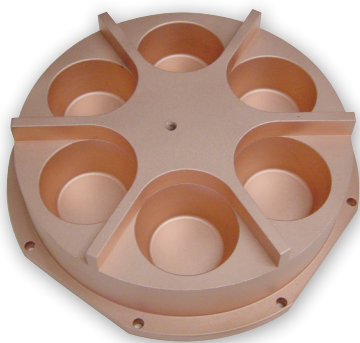

SIZE	TEMESCAL		Fil-Tech	
4x15cc Pockets	0715-8444-0	\$1,995	EB8444	\$1,700
6x15cc Pockets	0715-8504-0	1,995	EB8504	1,800
4x25cc Pockets	0715-8454-0	1,995	EB8454	1,700

SIZE	TELEMARK		Fil-Tech	
6x15cc Pockets	271-0255-3	\$2,250	EB0255-3	\$1,900
4x25cc Pockets	271-0220-3	2,250	EB0220-3	1,900
6x25cc Pockets	271-0257-3	2,250	EB0257-3	1,900

All high water flow

## Crucible Covers

SIZE	TEMESCAL		Fil-Tech	
4 Pockets	0715-8143-0	\$675	EB8143	\$600
6 Pockets	0715-8153-0	780	EB8153	650

SIZE	TELEMARK		Fil-Tech	
4 Pockets	271-0073-1	\$1,150	EB0073	\$545
6 Pockets	271-0074-1	1,150	EB0074	545

## Silicon Dioxide

High purity SiO<sub>2</sub> specifically designed for electron beam evaporation.

### SPECIFICATIONS

Purity	99.99%	Melting point	1713°C
Form	Granular	Refractive index	n/d 1.46 @500 nm

### ORDERING INFORMATION

EM0024-5	2-4 Granular size (mm)	\$100 (500g)
----------	------------------------	--------------

## Crucible Liners

Fil-Tech supplies 4cc, 7cc, 15cc, 25cc, 30cc and 40cc crucible liners for Temescal and Telemark electron beam gun crucibles. Available in Graphite, Tungsten, Molybdenum, Aluminum Oxide, Boron Nitride, Copper, Intermetallic, Tantalum, and Vitreous Carbon. We can also fabricate custom liners for your e-beam guns.



	SIZE	REMARKS	TEMESCAL	TELEMARK	Fil-Tech	
GRAPHITE	7CC		0627-6172-1	271-7007-1	EC0007-1	\$40
	15CC		0627-6172-3	271-7015-1	EC0015-1	50
	25CC	4 Pocket	0627-6172-5	271-7025-1	EC4025-1	60
	25CC	6 Pocket	N/A	271-7025-2	EC6025-1	65
	30CC	W/Web	N/A	271-7030-1	ECW030-1	75
	30CC	W/O Web	N/A	271-7030-2	EC0030-1	80
	40CC		0627-6172-7	271-7040-1	EC0040-1	80
TUNGSTEN	7CC		0627-6152-1	271-7008-9	EC0007-2	\$180
	15CC		0627-6152-3	271-7016-9	EC0015-2	185
	25CC	4 Pocket	0627-6152-5	271-7026-9	EC4025-2	255
	25CC	6 Pocket	0627-6152-6	271-7027-9	EC6025-2	300
	30CC	W/Web	N/A	N/A	ECW030-2	195
	30CC	W/O Web	N/A	N/A	EC0030-2	300
	40CC		0627-6152-7	271-7041-9	EC0040-2	310
MOLYBDENUM	7CC		0627-6162-1	271-7007-3	EC0007-3	\$110
	15CC		0627-6162-3	271-7015-3	EC0015-3	100
	25CC	4 Pocket	0627-6162-5	271-7025-3	EC4025-3	155
	25CC	6 Pocket	N/A	271-7025-4	EC6025-3	180
	30CC	W/Web	N/A	271-7030-3	ECW030-3	185
	30CC	W/O Web	N/A	271-7030-4	EC0030-3	180
	40CC		0627-6162-7	271-7040-3	EC0040-3	190

SHOP  
ONLINE  
NOW!

ALL ITEMS  
IN STOCK

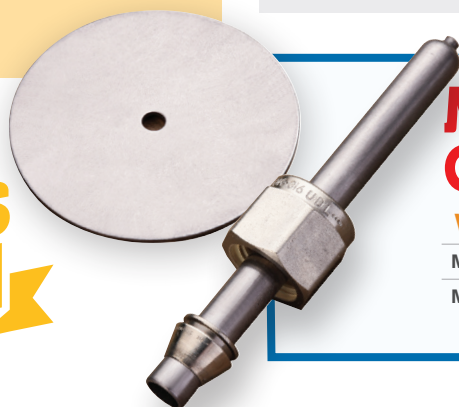

## MARK II Cathode Tip & Keeper

	VEECO		Fil-Tech	
MARK II Cathode Tip	B17968/SP	\$380	IS17968	\$315
MARK II Keeper	A17973	\$157	IS17973	\$70



# ION SOURCE PARTS

- Veeco Mark I & Mark II • Ion Tech
- Satisloh • Kaufman & Robinson

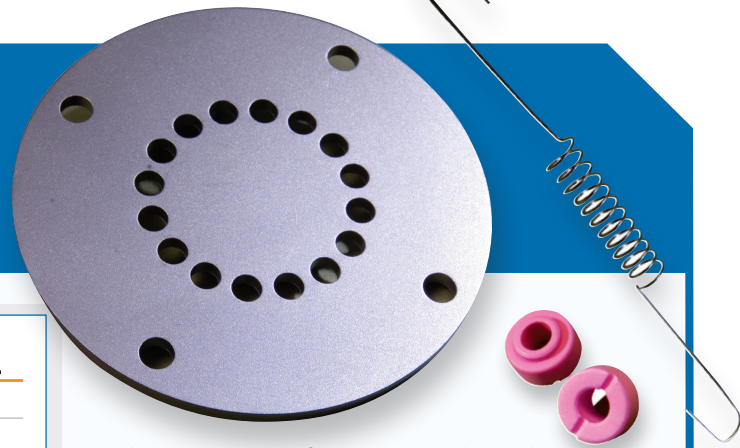

Replacement parts for Veeco Mark I and II, Ion Tech, Satisloh and Kaufman & Robinson ion source equipment. Filaments, insulators, anodes, gas distributors, cathode tips, keepers and other parts are drop-in replacements for the competitive parts listed and offered from stock at competitive pricing.

**SHOP ONLINE NOW!**

## Filaments

	VEECO	SATISLOH	Fil- <b>Tech</b>	
<b>MARK I</b>	A30274	\$7.20	A7500800Q-131M	IS30274 \$6
<b>MARK II</b>	A16962	7.60	A7500800Q-101M	IS16962 5
<b>VEECO / ION TECH</b>			Fil- <b>Tech</b>	
3&5cm Cathode	0503-107	\$50		IS3107 \$12
3cm Neutralizer	0503-063			IS3063 14
5cm Neutralizer	0505-001-003	64		IS1003 6
<b>KAUFMAN &amp; ROBINSON</b>			Fil- <b>Tech</b>	
EH1000	HFL-A01			ISKRLA01 3.50
EH200 & EH400	HFM-A01			ISKRMA01 3

## Insulators

	VEECO	SATISLOH	Fil- <b>Tech</b>	
<b>MARK I</b>	1451001	\$ 7.82	A7500800Q-136M	IS1001 \$6
<b>MARK I &amp; II</b>	10-32M		A7500800Q-167M	IS1032 6.50
	10-32F		A7500800Q-134M	IS1032F 10
	6-32F			IS0632F 12
	6-32M			IS0632M 8
	6-MS	8.50		IS06MS 8
	1/4-20M	15.60		IS2520M 12
	1/4-20F	15.60		IS2520F 12
<b>VEECO/ION TECH 3 &amp; 5CM</b>			Fil- <b>Tech</b>	
	0500-035 M	\$7.35		IS0035 \$6
	0500-036 F	9.80		IS0036 7
	0500-037 M	8.50		IS0037 7
<b>KAUFMAN &amp; ROBINSON</b>			Fil- <b>Tech</b>	
<b>INSULATORS</b>	10-32M	Insulator		IS1032 \$6.50
	10-32M-2	Insulator		IS0035 8
	6-32M	Insulator		IS0632M 8
	1/3-20m-1	Insulator		IS2520M 12
<b>REFLECTOR</b>	ISKR1012G	Graphite Reflector		EH10-12-CG 75

## Anodes

	VEECO	SATISLOH	Fil- <b>Tech</b>	
<b>MARK I</b>	B18003-1 Graphite	\$77	A7500800Q-132M	IS18003G \$65
	B18003-2 Stainless	57	A7500800Q-133M	IS18003S 55
	<b>MARK II</b> B16933-1 Graphite	196	A7500800Q-175M	IS16933G 160
	B16933-2 Stainless	144	A7500800Q-166M	IS16933S 85

## Mark II Parts

Mark II	Description	Fil- <b>Tech</b>	
B16923	Pole Piece, Outer	IS16923	\$202
B16927	Alnico-5 Magnet	IS16927	67
B16928	Support Plate	IS16928	361
B16929	Baffle	IS16929	26
B16930	Spacer	IS16930	28/3
B16932	Support, Back Anode	IS16932	185
B16934	Support, Front Anode	IS16934	198
B16935	Tie Rod, Short	IS16935	38/2
B16936	Tie Rod, Long	IS16936	38/2
B16937	Cathode Connection	IS16937	105/2
B16938	Anode Connection	IS16938	19
B16939	Support, Cathode	IS16939	122/2
B16940	Knob, Hold Down	IS16940	50/2
B16944	Retainer, Cable	IS16944	106/3
B16946	Cover, Empty Socket	IS16946	70
B16947	Work Station	IS16947	100
B29958	Pin, Alignment	IS29958	42/2
B29959	Screw, Hold Down	IS29959	72/2
B29960	Socket	IS29960	298
B29961	Plug	IS29961	395

## Gas Distributors

	VEECO	SATISLOH	Fil- <b>Tech</b>	
<b>MARK I</b>	B18005-1 Graphite	\$356	A7500800Q-134M	IS18005G \$100
	B18005-3 Stainless	75	A7500800Q-135M	IS18005S 75
	B18005-5 Titanium	455		IS18005T 100
<b>MARK I MODIFIED HOLES</b>	B18005-1A Graphite			IS18005G-1 100
	B18005-2A Stainless			IS18005S-1 90
	B18005T-1 Titanium			IS18005T-1 100
<b>MARK II</b>	B16931-1 Graphite	554	A7500800Q-174M	IS16931G 240
	B16931-2 Stainless	109	A7500800Q-154M	IS16931S 65
	B16931-5 Titanium	209	A7500800Q-202M	IS16931T 100

Call 800-743-1743 For a complete listing of Mark I, I+, II and II+ parts.